

GETTING STARTED WITH **CONTINUOUS GLUCOSE MONITORING**

Guardian™ Connect System

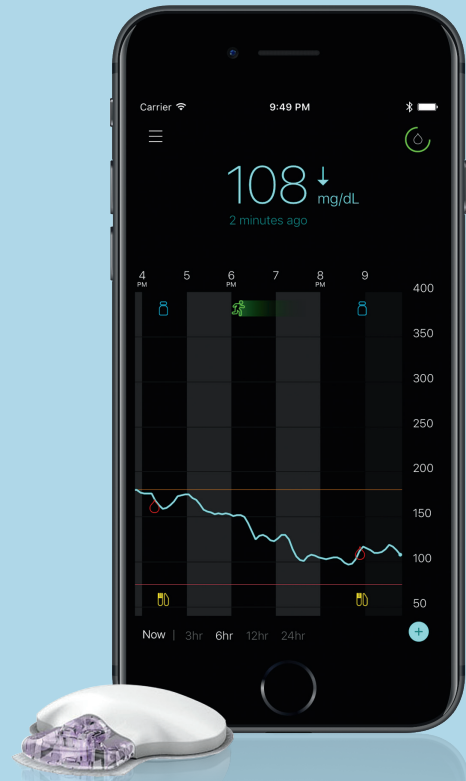

Medtronic

GETTING STARTED WITH CONTINUOUS GLUCOSE MONITORING (CGM)

Guardian™ Connect System

Section 1: What's Continuous Glucose Monitoring?	3
Section 2: Setting Up Your Guardian™ Connect System	4
System Components	4
CareLink™ Sign In	6
Phone Settings	7
App Settings	8
Alert Volume	11
Mute All Alerts	11
Sensor & Transmitter Setup	14
Section 3: Using Your Guardian™ Connect System	25
Calibrating your Sensor	25
Adjusting Alert Settings.....	27
Alerts Turned Off.....	28
Alerts You May Receive	29
Reading your App Display.....	31
Entering Event Markers.....	34
Section 4: Setting Up Your Care Partner Account	35
Section 5: Appendix	39

WHAT IS CONTINUOUS GLUCOSE MONITORING?

Section 1: Welcome to CGM

Continuous glucose monitoring (CGM) lets you see more glucose values than when you check with your blood glucose meter. You will get up to **288 sensor glucose readings every 24 hours**, that fill the gaps between your blood glucose checks. CGM can alert you to your high and low glucose levels too.

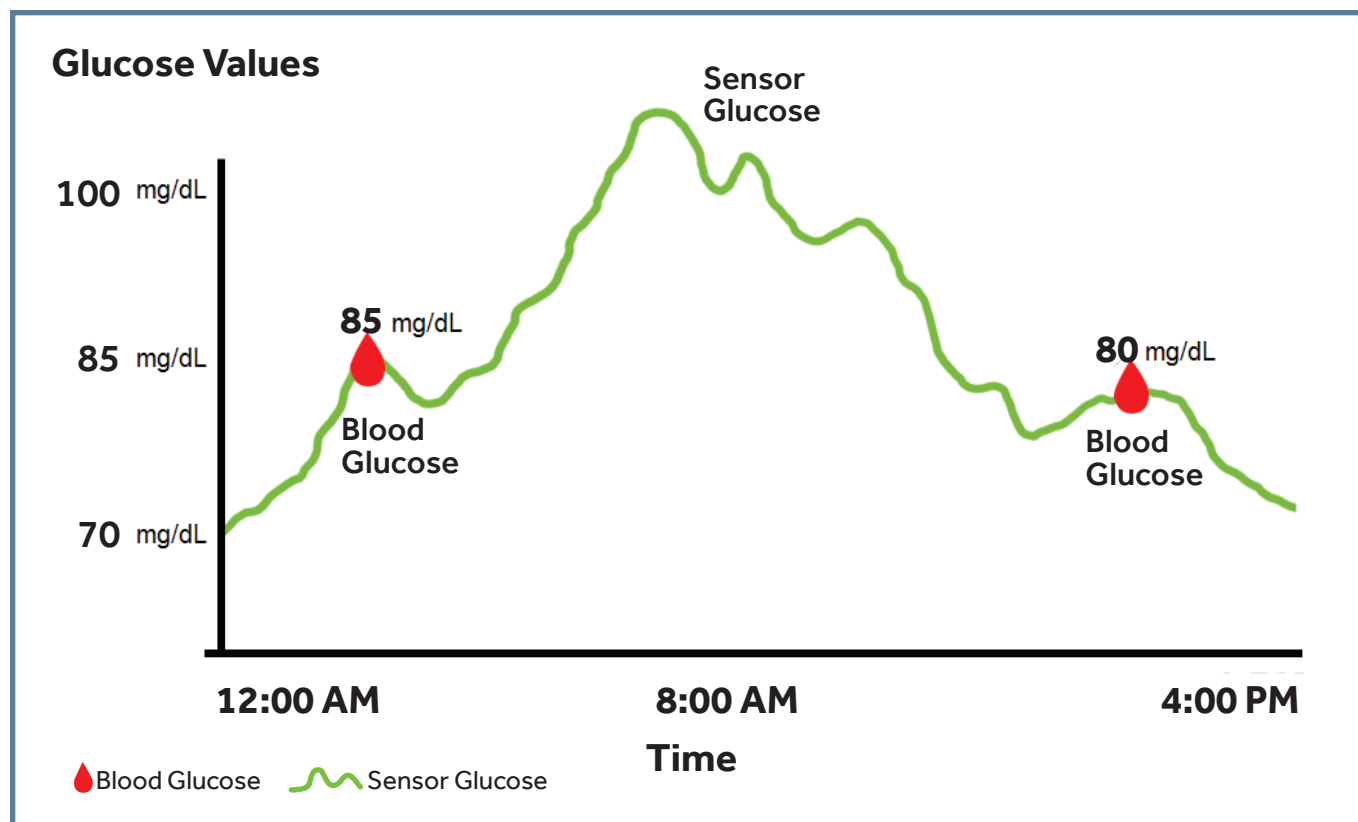

WARNING If you take medications with acetaminophen such as Tylenol®, fever reducers, cold medicine, or paracetamol while you wear the sensor, your sensor glucose readings might become falsely raised. The level of sensor inaccuracy will depend on how much acetaminophen is working in your body and will be different for each person. Always use your blood glucose meter to confirm your glucose levels before you make therapy decisions.

Your sensor glucose (SG) is not the same as your blood glucose (BG). Your SG and BG readings will be similar to one another but will rarely match exactly.



WARNING Do not make therapy decisions based on your sensor glucose values because your sensor glucose and blood glucose values may be different. Confirm your glucose level with your blood glucose meter before making treatment decisions, such as dosing insulin before a meal or taking carbs to treat a low.

If you “feel” that your glucose is high or low, but your sensor glucose doesn’t match what you’re feeling, always check your blood glucose using your BG meter.

Section 2: Setting up your Guardian™ Connect System

1. Search for "Guardian Connect" in your phone's app store and install the app.



2. Open the Guardian Connect app and tap Agree if you accept the end user license agreement.

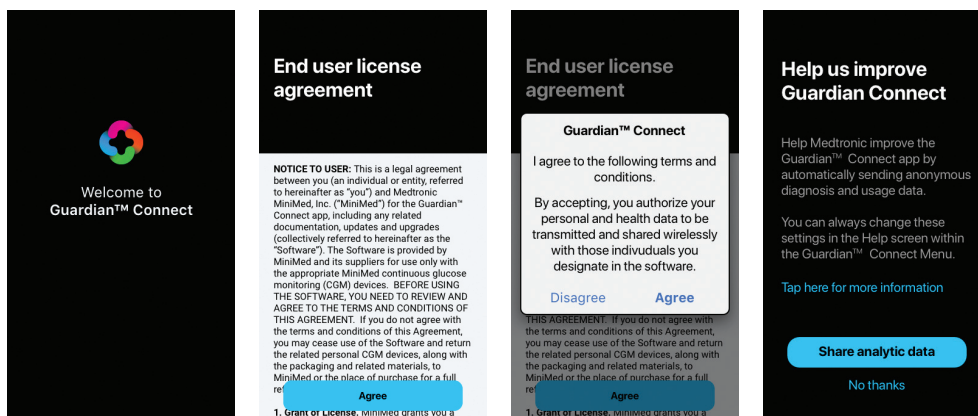

3. Gather the components of your Guardian Connect system.

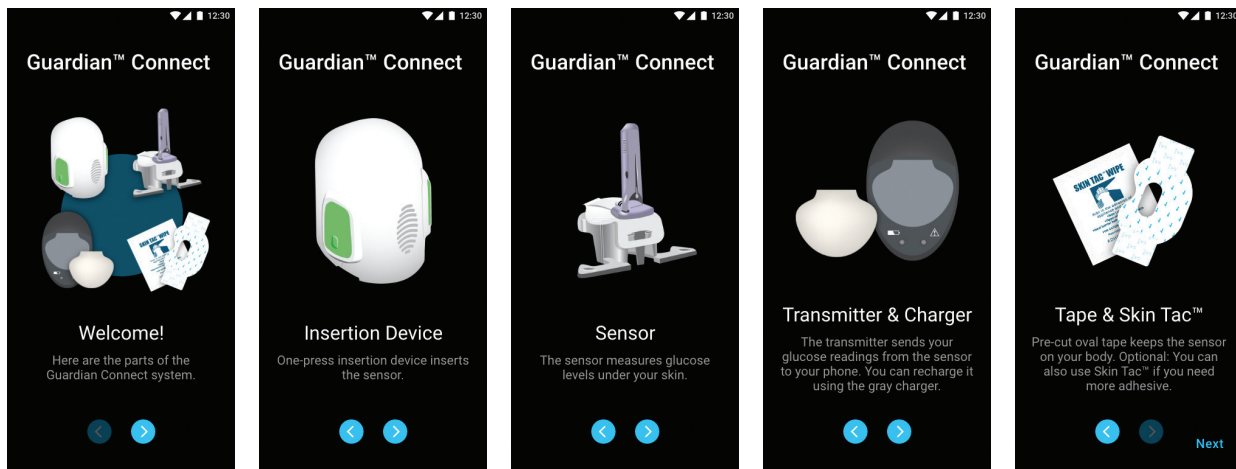

4. Connect your transmitter to the gray charger. The green light on your charger will flash green. You will know that your transmitter is fully charged when the charger light turns off. It can take up to 2 hours for your transmitter to become fully charged.

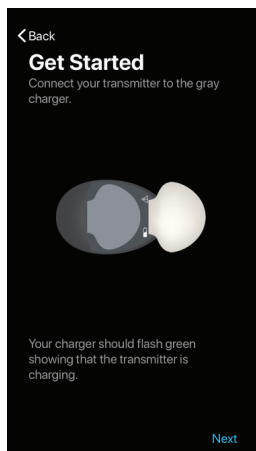

5. Turn on Bluetooth™ in your phone. Make sure that your phone has an internet connection either through a mobile data plan or Wi-Fi. Always keep these two turned on.

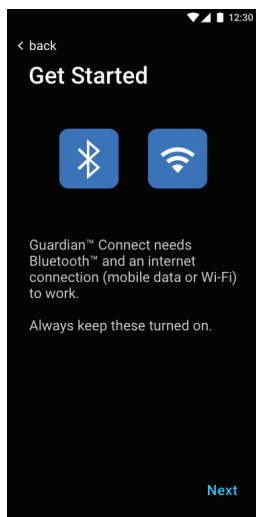

- Please make sure you have set aside enough time to complete the setup of your system.

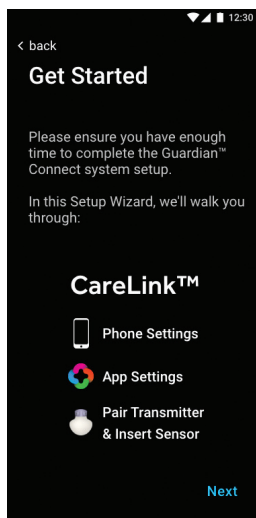

- Sign into your CareLink™ account. If you do not have an account or you forgot your password, tap the correct link on the screen, either "Create a CareLink Account?" or "Forgot Password?".

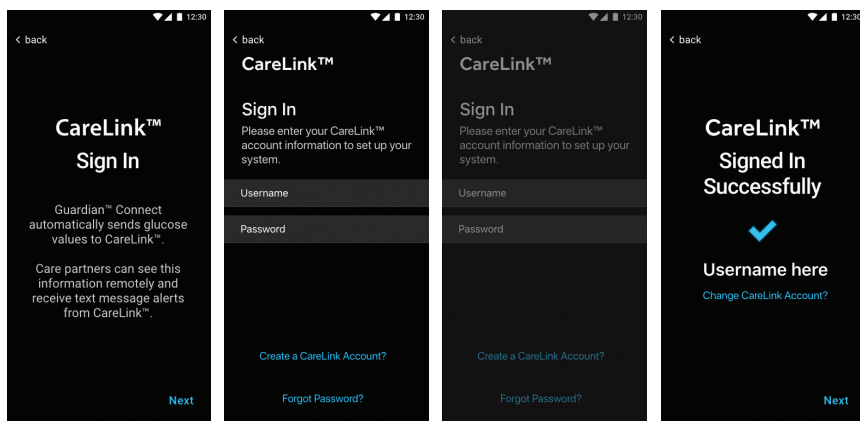

SETTING UP YOUR GUARDIAN CONNECT SYSTEM

- For Apple™ users (iPhone or iPod): Read all the important warnings for your phone settings. If you use an Apple™ device (iPhone or iPod), it is important that you always keep Notifications and Critical Alerts turned ON in your phone's settings to ensure that you receive your Guardian Connect notifications.

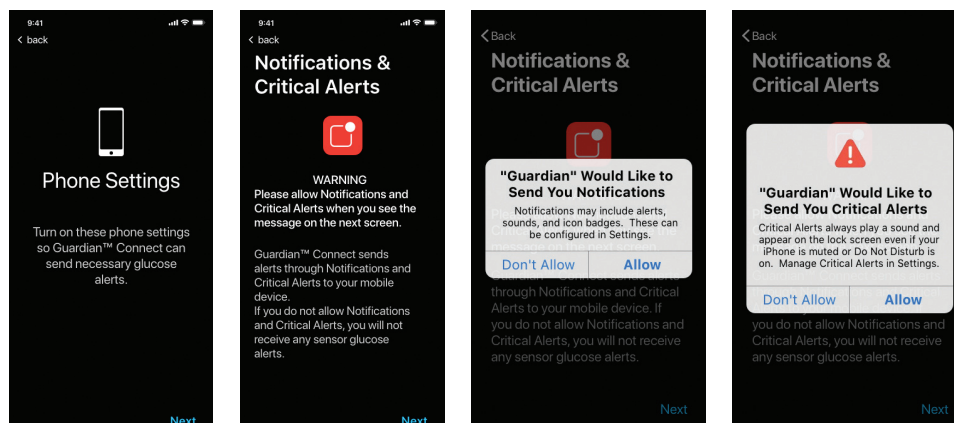

- For Apple™ users (iPhone or iPod): Your phone's Settings have a feature called Screen Time that allows you to block apps during a Down Time period that you set. If you choose to use this feature, it is very important that you add the Guardian Connect app to the "Always Allowed" apps. Otherwise, you will not get any alerts during Down Time.

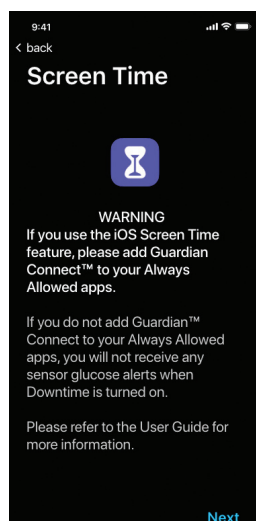

WARNING: Do not use any phone settings such as Screen Time (in Apple™) or Digital Wellbeing (in Android™) that may prevent Guardian™ Connect from sending you alerts.

If you set the app timer in Digital Wellbeing for your Guardian™ Connect app and let it expire, your Guardian™ Connect app will shut down and you will not get any sensor glucose alerts.

10. For Android™ users: Your phone's Settings allow you to turn on Do Not Disturb to avoid being bothered by phone calls, text messages, app alerts, and other notifications. However, to continue getting sensor glucose alerts from your Guardian™ Connect app, it is important that you allow the Do Not Disturb Permission when asked on your screen.

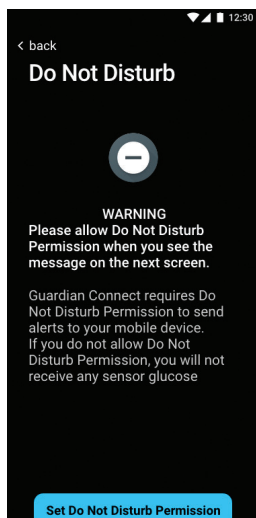

WARNING for Android™ users! Do NOT turn off Notifications or Do Not Disturb Permission in your mobile device's Settings or you will not receive any Guardian Connect alerts including the Urgent Low Sensor Glucose Alert.

11. Now, let's cover your Guardian™ Connect app settings.

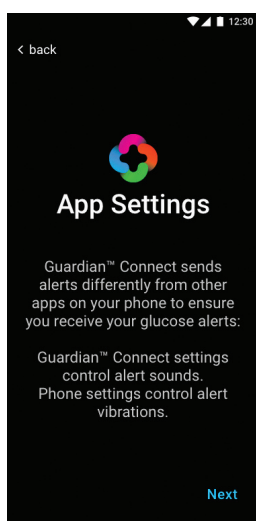

12.



WARNING Do not use your sensor glucose value to decide to treat a low or high glucose. You must check your blood glucose with your meter instead.

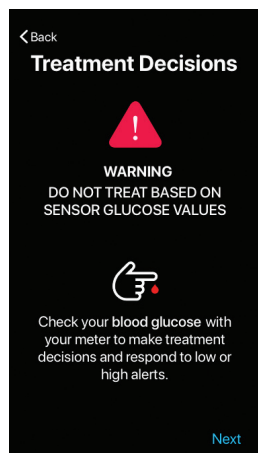

13. You will always receive an Urgent Low Sensor Glucose Alert that sounds or vibrates when your sensor glucose value reaches or falls below 55 mg/dL. This setting cannot be changed.

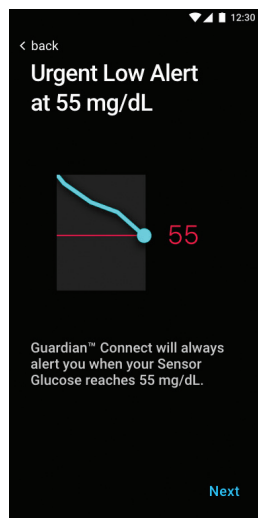

- 14.** Your sensor glucose alerts are already set to alert you at 70 mg/dL both day and night. But you can adjust these settings if you need to. If your sensor glucose reaches 70 mg/dL at night, you will receive a Low Sensor Glucose Alert that sounds at maximum volume to help you hear the alert if you are sleeping.

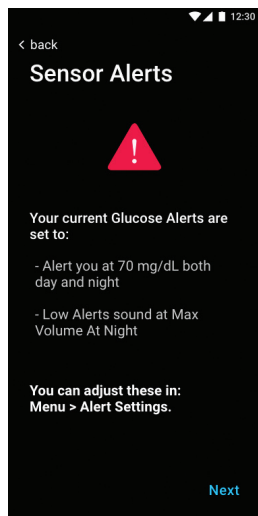

- 15.** The setting called Max Volume at Night will play your low and/or high alerts at the loudest volume at night to help you hear them while you are sleeping. You can change this setting in Alert Settings.

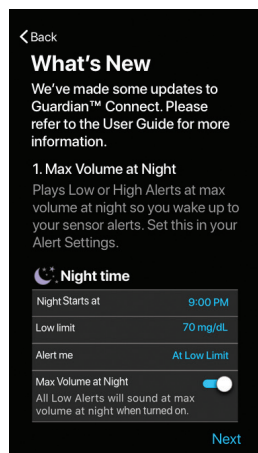

Alert Volume

- 16a.** You can control the volume of your alerts by going to the **Menu** and then **Alert Volume**. Slide the volume bar to the left to decrease the volume of your alerts or to the right to increase the volume.



IMPORTANT: If you do not respond to the alert, then the alert will sound louder and repeat every few minutes until you address it. **Alert Volume** only controls the sound of your alerts.

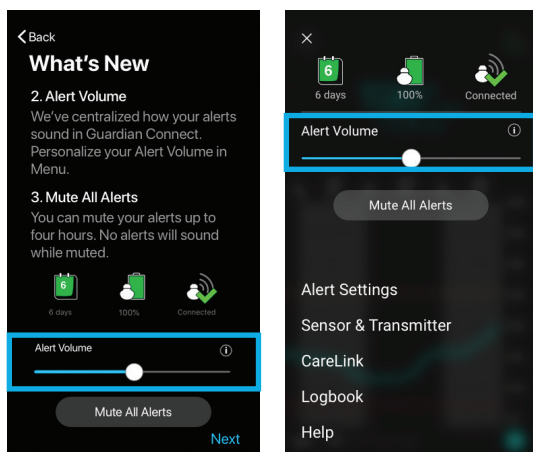

Mute All Alerts

- 16b.** You can prevent all of your alerts from making any sound by going to the **Menu** and tapping **Mute All Alerts** to silence all your alerts for up to 4 hours. None of your alerts will make a sound for the entire time that you choose.



NOTE: When Mute All Alerts is set, the Urgent Low Sensor Glucose Alert will still vibrate but will not sound. The other alerts will also vibrate if your phone vibration setting is turned on. **Mute All Alerts** only controls the sound of your alerts.

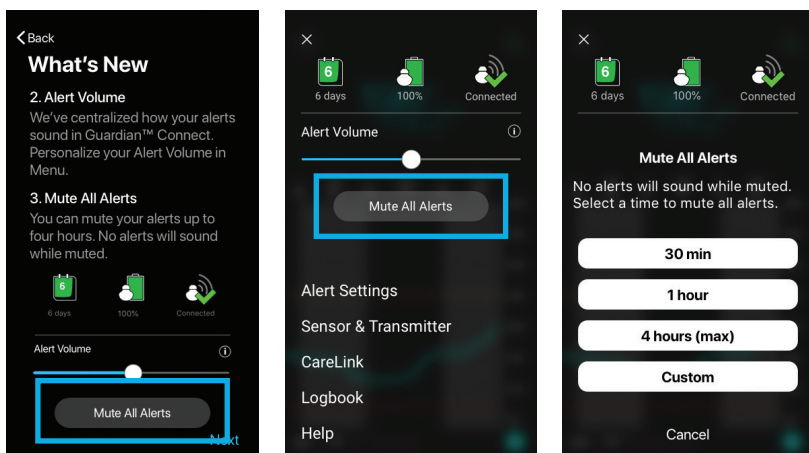

An icon will appear at the top of your Home Screen showing that all your alerts are muted. You can tap the icon to check how long until the mute time ends.

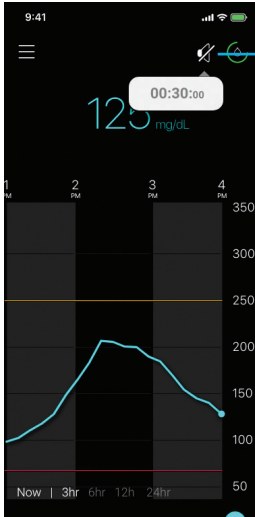

Icon showing All Alerts Muted

You can tap **Cancel Mute** on your **Menu** screen at any time.

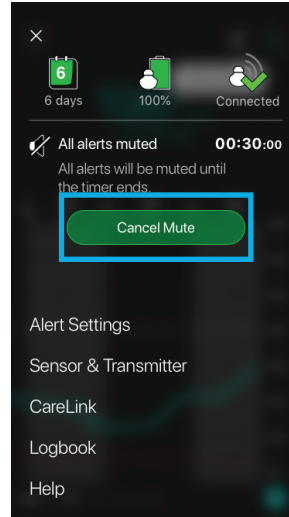

WARNING for Apple™ users: Do not turn off vibration in your phone's Accessibility menu. Otherwise, you will not get any vibrations with your alerts, including Urgent Low.

WARNING for Android™ users: Do not lower the vibration feedback to the lowest level in your phone's Vibration Intensity menu. Otherwise, you will not get any vibrations with your alerts, including Urgent Low.



KNOWLEDGE CHECK 1

What's the difference between sliding the Alert Volume to zero volume versus selecting Mute All Alerts?

Answer: If you set your Alert Volume to zero volume, your app alerts will be silenced. However, if you do nothing to address the alerts, they will begin to sound and repeat every few minutes. If you select Mute All Alerts, you must choose the amount of time that you want to silence all app alerts. No alerts will sound for the entire time that you set whether you respond to the alerts or not.



KNOWLEDGE CHECK 2

Let's say you're going to a movie and you tap Mute All Alerts and set it for 3 hours. What would happen if you get a Low Sensor Glucose Alert during the 3 hours?

Choose the correct answer:

- A. When I first get the Low Sensor Glucose Alert it would not make a sound, but it would get louder after a few minutes if I don't do anything about the alert.
- B. The Low Sensor Glucose Alert would not make any sound for the entire 3 hours.
- C. The Low Sensor Glucose Alert would show on my phone.
- D. Both B and C

KNOWLEDGE CHECK 3

This time you're going to a meeting and you slide the Alert Volume to zero. What would happen if you get a Low Sensor Glucose Alert?

Choose the correct answer:

- A. When I first get the Low Sensor Glucose Alert it would not make a sound, but it would get louder after a few minutes if I don't do anything about the alert.
- B. The Low Sensor Glucose Alert would not make any sound whether I do something about the alert or not.
- C. The Low Sensor Glucose Alert would show on my phone.
- D. Both A and C

Answer:
Knowledge Check 2 is D
Knowledge Check 3 is D

17. Let's continue with setting up your transmitter and sensor. Make sure your transmitter is plugged into the gray charger to start. To pair the transmitter to your app, unplug the transmitter from the gray charger as shown in the on-screen animation. The transmitter will show a flashing green light. Then tap Search at the bottom of your screen. The app will begin to search for your transmitter.

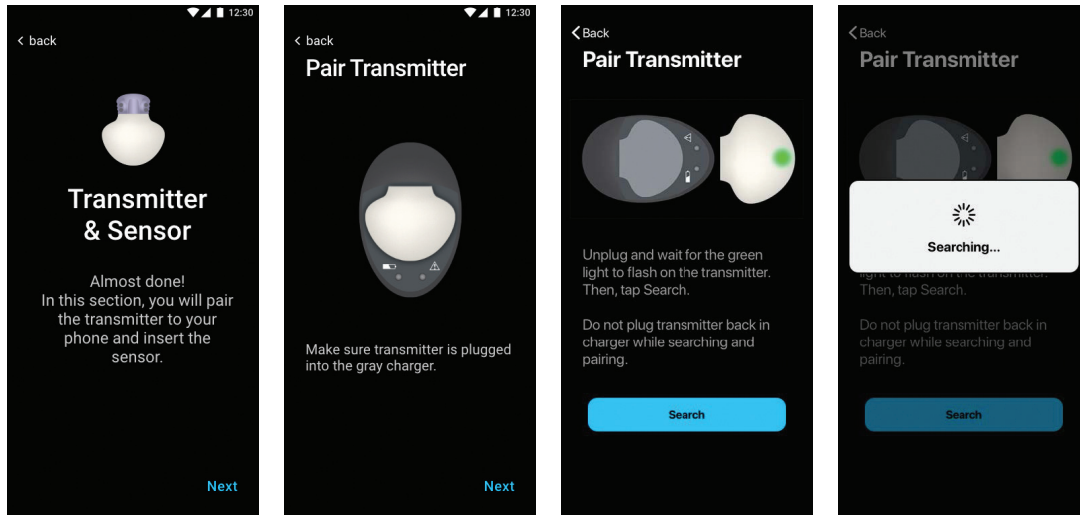

18. Next, check the back of your transmitter and compare the serial number to the one on your app. Tap the matching serial number on your app screen to begin pairing.

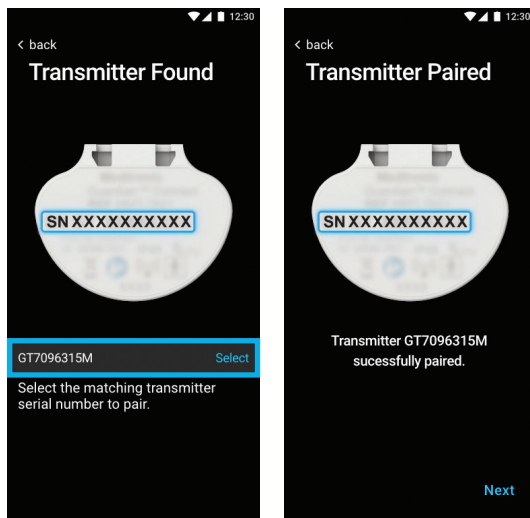

19. The final part of your Guardian Connect system setup is to insert the sensor. Go ahead and watch the video or go to the printed instructions on the next pages of this Getting Started Guide to help you insert your sensor. After you insert your sensor, tap **Start Sensor** on your app.

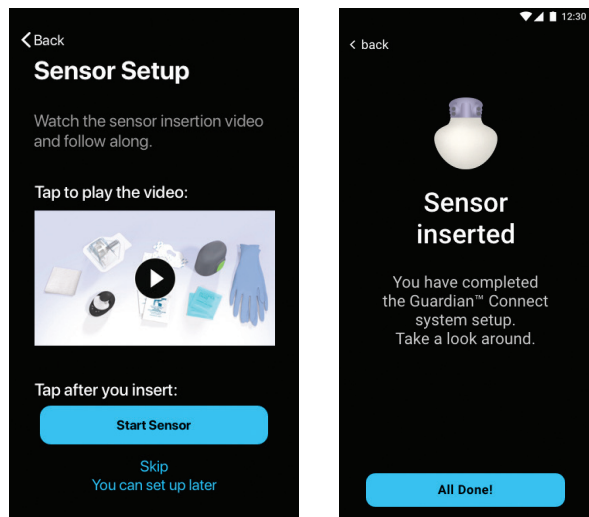

It will take up to 2 hours for your sensor to warm up before you receive a Calibrate Now alert. After you enter your blood glucose to calibrate the sensor, you will begin to see sensor glucose values on your home screen. Go to Section 3 of this Getting Started Guide to learn how to calibrate.



WARNINGS: If you close the app, you will not receive any sensor glucose information or alerts. The app needs to be open or running in the background in order for you to get sensor glucose information.

Every now and then you should check that your app is still open and running. If you're running a few apps at once, it's possible that your Guardian™ Connect app might close. You may see a "Lost Communication" notification if it closes.

If your mobile device shuts off and turns back on, your app will not reopen on its own. Open the app again after restarting your mobile device in order to avoid missing sensor glucose information and alerts.



Don't assume my app is always open and able to give alerts. Must check app is still running.



WARNING: You won't receive any sensor glucose alerts if Bluetooth® is turned off in your mobile device. If you turn on Airplane mode, make sure to turn on Bluetooth®.



WARNING: Do not use your Guardian™ Connect app if your mobile device screen or speakers are damaged. Otherwise, you may miss important sensor information and alerts.



WARNING for Apple™ users! Do NOT turn off Notifications or Critical Alerts in your mobile device's Settings or you will not receive any Guardian Connect alerts including the Urgent Low Sensor Glucose Alert.

WARNING for Android™ users! Do NOT turn off Notifications or Do Not Disturb Permission in your mobile device's Settings or you will not receive any Guardian Connect alerts including the Urgent Low Sensor Glucose Alert.



NOTE: Do not root or jailbreak the mobile device. Rooting the Android™ device or jailbreaking the iOS device means to change the software in a way the manufacturer did not intend. If the mobile device is changed in this way, the Guardian app will display an error message when launched and will not continue to operate.

Gathering Materials to Insert Your Sensor

Gather all of your supplies to insert your sensor.

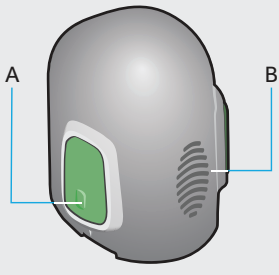
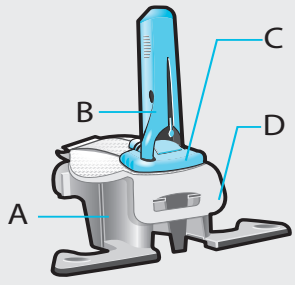
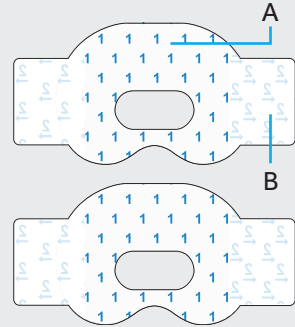
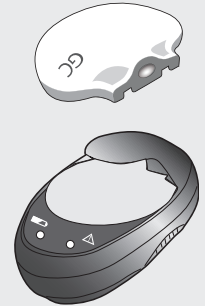
GUARDIAN SENSOR 3 SYSTEM COMPONENTS*			
			
<p>One-Press Sertter</p> <p>A – Green buttons B – Thumbprint marking</p>	<p>Glucose Sensor Assembly</p> <p>A – Pedestal B – Needle housing C – Sensor base D – Clear liner</p>	<p>Oval Tape (2 pieces)</p> <p>A – Liner 1 B – Liner 2</p>	<p>Guardian Connect Transmitter and Charger</p>
<p>Sertter is needed to insert the sensor properly</p>	<p>Sensor is individually packaged and comes attached to a plastic pedestal which is necessary to properly load the sensor inside the sertter</p>	<p>Oval tape is required to keep the sensor in your body</p>	<p>Transmitter is connected to the sensor that is inserted into the body</p> <p>Charger is used to charge transmitter</p>

*Check the Guardian Sensor 3 User Guides for more information.



WARNING: Do not expose your sensor or transmitter to Magnetic Resonance Imaging (MRI) equipment, diathermy devices, or other devices that generate strong magnetic fields (for example, x-ray, CT scan, or other types of radiation). Always remove your sensor and transmitter before entering a room that has x-ray, MRI, diathermy, or CT scan equipment. Exposing your sensor or transmitter to a strong magnetic field has not been evaluated and can cause the devices to malfunction, result in serious injury or be unsafe.

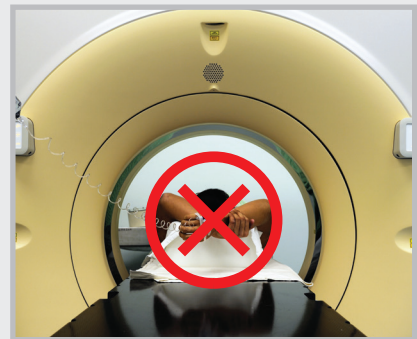

Selecting Your Insertion Site

Choose a site that has enough fat on your **back of your upper arms or abdomen (for ages 14 and older)**. The images show the back of the upper arms and abdomen that you can use.**



NOTE: You may need assistance or a mirror to help you with inserting the sensor. Some users may find it difficult to insert the sensor onto the buttock or back of the arm by themselves.

Insert your sensor at least:

- 2 inches (5 centimeters) from your navel
- 1 inch (2.5 centimeters) from your infusion set
- 1 inch (2.5 centimeters) from any manual insulin injection site

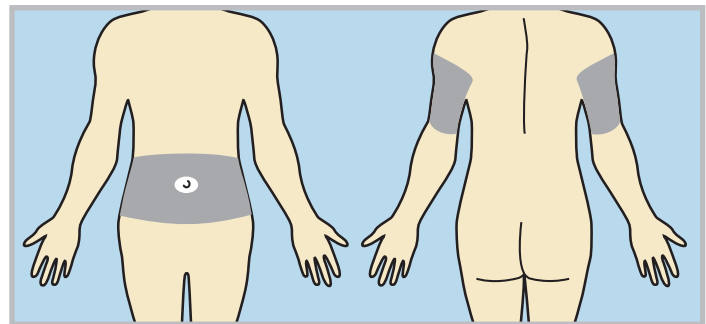

Abdomen:
See pages 16-22

Back of upper arm

For best sensor glucose performance, avoid sites:

- Where your clothing may rub or be too tight (such as your beltline)
- Where your body naturally bends a lot as this may cause the sensor to pull out
- That are scarred, have hardened tissue or stretch marks
- Where there is a lot of movement or rubbing (such as the inside of your arm)

** Glucose sensors were inserted in the shaded areas of the back of the upper arms and abdomen

Preparing My Site

- Wash your hands with soap and water.
- Clean the site you chose with an alcohol swab and allow the alcohol to dry. Do not use IV prep..

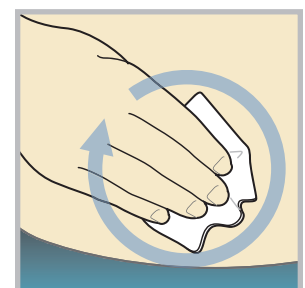
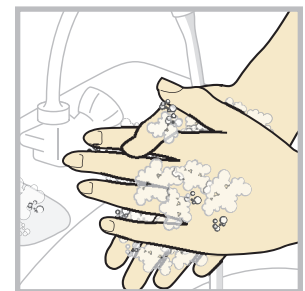

WARNING: Only use the One-pressserter to insert the Guardian Sensor 3. Other Medtronic sersers do not work the same way. Follow all instructions carefully to avoid improper insertion, pain, or injury.

Only use the Guardian Sensor 3 with a compatible transmitter. Otherwise, the components may become damaged or you may get inaccurate sensor readings.

Inserting My Sensor

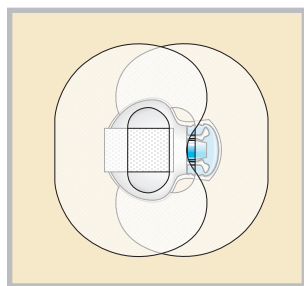

Example of Guardian Sensor 3 after it is inserted and taped.



1 Open the sensor package. Pull the corner of the paper covering to open the sensor package.

WARNING: Sensors are sterile unless the package has been opened or damaged. Don't use the sensor if the package is opened or damaged before use.

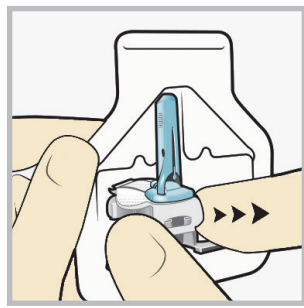

2a Hold sensor by plastic pedestal. Hold the pedestal and remove the entire sensor assembly from the package. Place the sensor / pedestal on a clean, hard, flat surface (a table).

The tab is tucked

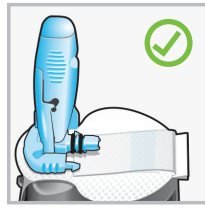

Correct



Incorrect

2b Tuck adhesive tab.

Make sure that the sensor's adhesive tab is tucked under the sensor connector and snaps.

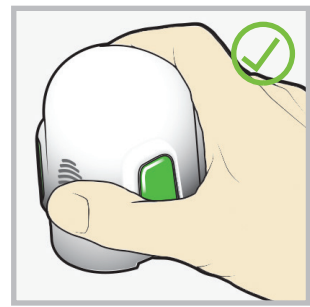

Correct



Incorrect

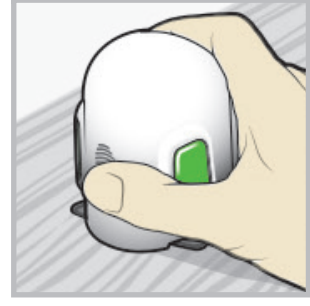
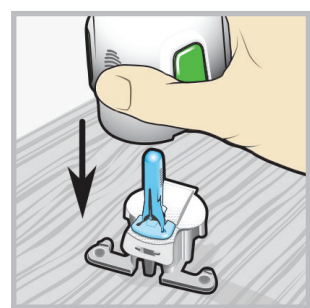

3 Hold serter correctly. Place your thumb on the thumbprint marking to hold the serter without touching the green buttons.

4 Load sensor into serter. Grip the serter exactly as shown **with your thumb placed on the thumbprint marking. Do not hold the green buttons.** Carefully push the serter down onto the pedestal until the base of the serter sits flat on the table and you hear a click.

NOTE: The thumbprint on the serter can be used for either the left or right hand.

Inserting My Sensor, cont'd

Fingers are NOT holding the green buttons.

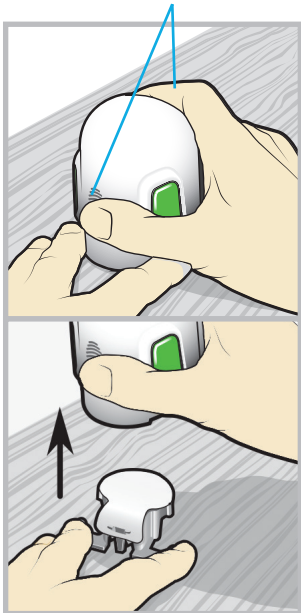

5 Detach serter from pedestal. Place your thumb of one hand on the thumbprint marking and grip the serter **without touching the green buttons.** With the other hand, place two fingers on the pedestal arms. Slowly pull the serter straight up. **Do not detach the pedestal from the serter in mid-air as this may damage the sensor.**



NOTE: The sensor stays inside the serter after you remove the pedestal. The arrow on each side of the serter shows the location of the sensor needle.

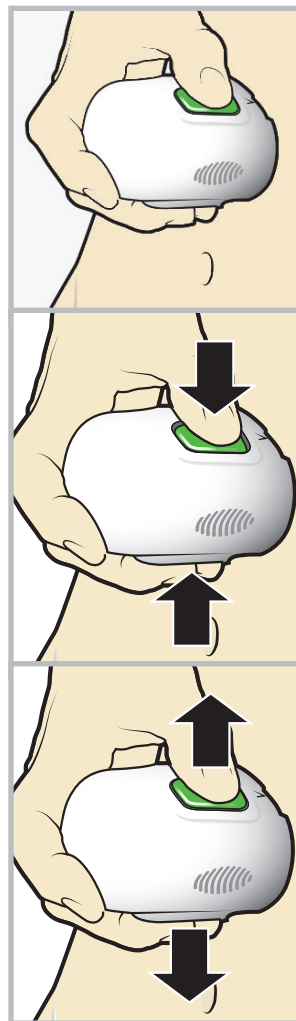
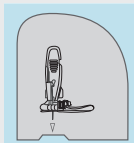

6a Place serter on body. Hold the serter flat and steady against the cleaned site that you chose. Don't push the serter into your skin.

6b Insert sensor. Press and release the bump on both green buttons at the same time. Don't pull the serter away from your body yet.



NOTE: If you don't hold the serter flat against your body when you press the buttons, the serter might spring back. This could cause the sensor to insert improperly.



6c Hold serter against body. Keep holding the serter against your body for at least five seconds to let the adhesive stick to your skin.

Do not press buttons

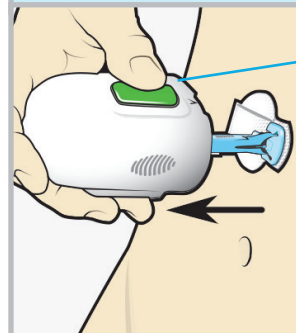

6d Remove serter from body. Slowly pull the serter away from your skin, **making sure the buttons are not pressed.**

Inserting My Sensor, cont'd

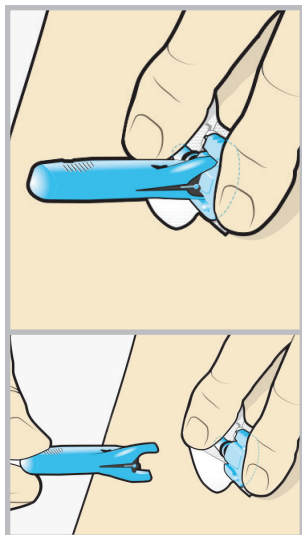

7 Remove needle housing. Hold the plastic sensor base against your skin. (Your fingers should be holding down both the sensor connector with black rings and the other end of the base.) Using your other hand, hold the tip of the needle housing and pull it straight out. Throw away the needle housing in a sharps container



WARNING: Check your sensor site for bleeding after you insert the sensor. If there is bleeding, put pressure on it using a sterile gauze for up to three minutes. If the bleeding doesn't stop, or there is a lot of blood under the plastic base, or you have pain, then remove the sensor and insert a new one in a different spot.

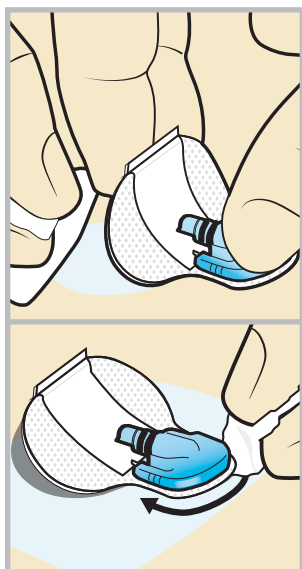

OPTIONAL: Apply additional liquid adhesive. You may use an optional liquid adhesive such as Skin Tac™ if you need the sensor to stick better. Lift the sensor adhesive pad and wipe the Skin Tac on your skin. You can also wipe the top of the adhesive pad and the edges around the sensor.

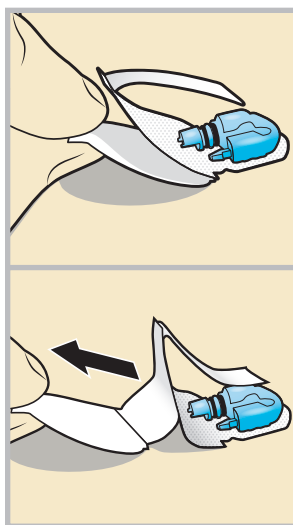

8a Remove adhesive pad liner. Gently hold down the sensor, and remove the paper liner from under the adhesive pad. Do not remove the liner on the rectangular adhesive tab yet.

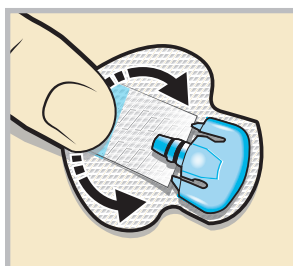

8b Press entire adhesive pad to skin. Firmly press the entire adhesive pad against your skin so that it sticks to your skin.



NOTE: The Guardian Sensor 3 adhesive sticks better when you press it to the skin well. Make sure to press it to your skin well in order for the sensor to stay inserted for the whole 7 days that you wear it.

Inserting My Sensor, cont'd

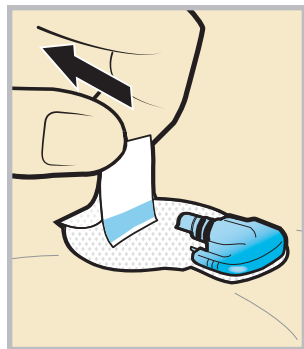

9a Untuck adhesive tab. Untuck the adhesive tab from under the sensor connector.

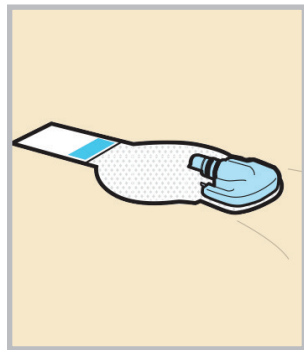

9b Straighten adhesive tab. Straighten the adhesive tab so that it lies flat against your skin, but don't remove the paper liner yet.

Taping Your Sensor with First Piece of Oval Tape

Before you connect the transmitter to your sensor it is very important that you properly tape the sensor using the oval tape.

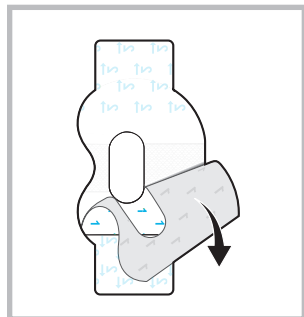

1 Remove liner 1 from oval tape.

Wide part of tape covers half of sensor base.

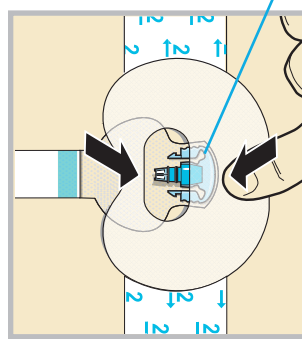

2 Apply the tape as shown and press down firmly.

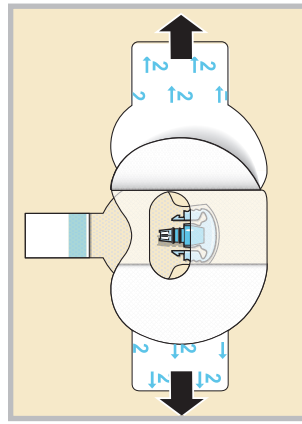

3 Remove liner 2 from each side.

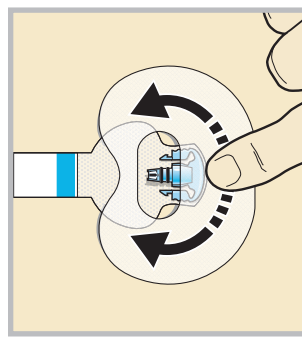

4 Smooth the tape.

Connecting Your Transmitter

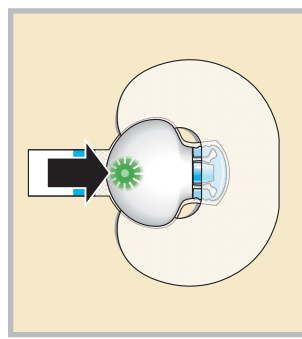

1 Connect the transmitter to your sensor. Note: Wait for the green light on the transmitter to flash. If the green light does not flash, check the Troubleshooting section of your transmitter user guide.

Connecting My Transmitter, cont'd



IMPORTANT: If you don't see a green light flashing on your transmitter after you connect it to your sensor, then disconnect the transmitter and plug it back into the charger to make sure that it is fully charged. Then try again and reconnect your transmitter to your sensor.

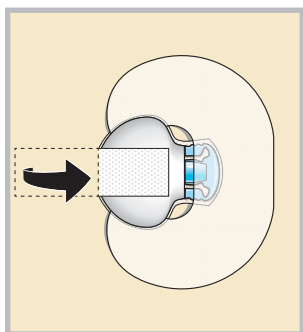

2 Stick the adhesive tab on the transmitter. Do not pull the tab too tightly when you stick it on the transmitter. Otherwise, the transmitter may lift from the skin.

Applying Second Piece of Oval Tape

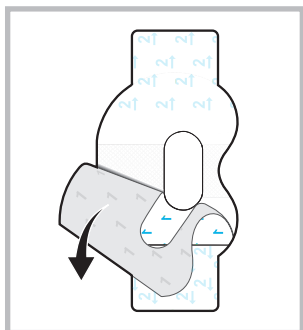

1 To apply the 2nd oval tape, remove liner 1.

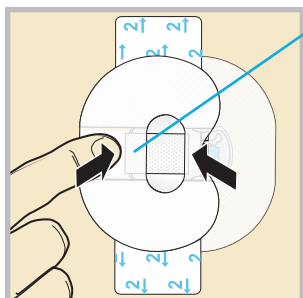

Wide part of tape covers end of transmitter and skin.

2 Apply the 2nd tape in the opposite direction to the first tape and place it on the transmitter. Press down firmly.

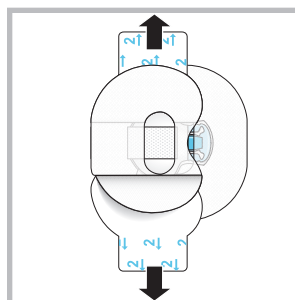

3 Remove liner 2 from each side.

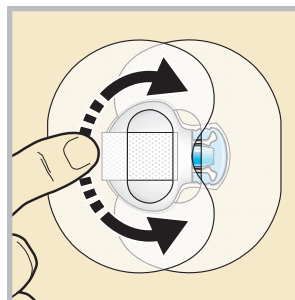

4 Smooth the tape.
Note: Check your sensor site regularly. Apply other off-the-shelf tape if your sensor and transmitter aren't secure.

Starting My Sensor

Now that you have inserted and taped your sensor, return to your Guardian Connect app on your mobile device to complete the sensor start up. Tap **Start New Sensor**.

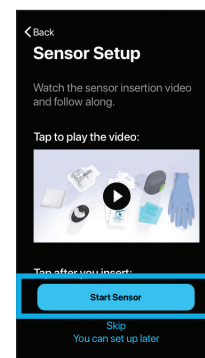

Removing Sensor in Seven Days

1. Peel off tape.
2. Disconnect transmitter by pinching side arms of sensor. Then pull transmitter away.
3. Plug transmitter into charger.
4. Peel off and throw away sensor.



NOTE: When your transmitter is connected to your sensor they are water-tight in 8 feet (2.4 meters) of water for up to 30 minutes. You can shower and swim without removing them.



NOTE: The oval tape is key to your success with the sensor. It's very important to apply the oval tape because your sensor is small and flexible. The oval tape will help prevent your body's motion from pulling it out.

Check that the Oval Tape was Applied Properly

Correct

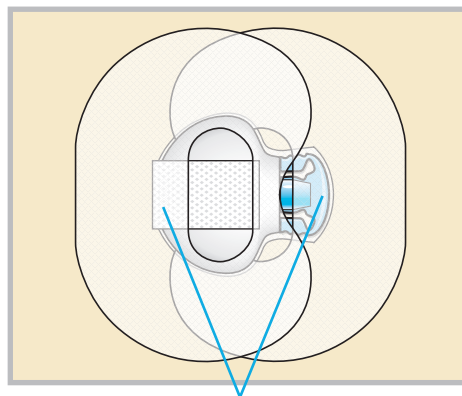

Oval tape is covering the sensor, skin around sensor, and back of transmitter.

Section 3: Using Your Guardian™ Connect System

Calibrating Your Sensor

You must calibrate your sensor to get sensor glucose values.

To calibrate:

1. Check your blood glucose with your meter.

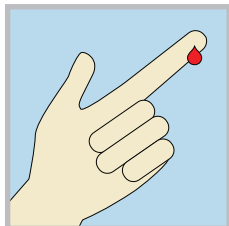

2. Tap the calibration icon at the top of your app home screen.

Tap icon to calibrate

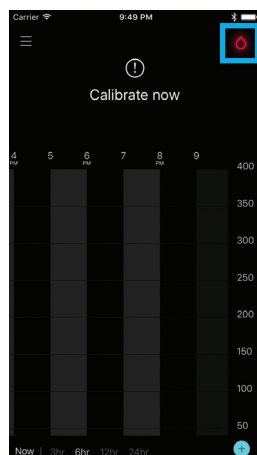

3. Enter your blood glucose value using the key pad. It will only accept 40-400 mg/dL.

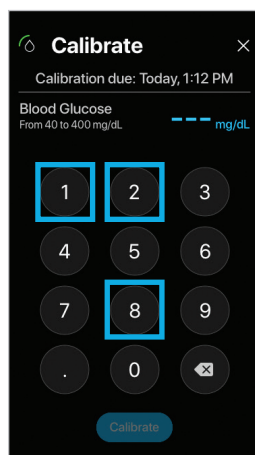

4. Tap **Calibrate** at the bottom of the screen.

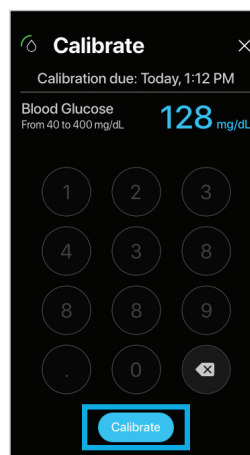

When to calibrate:

- When you get your first **Calibrate now** alert about 2 hours after you connect your transmitter to your sensor.
- Again within 6 hours after your first calibration but only on the first day of your new sensor.
- Again every 12 hours after your last calibration or when you get a **Calibrate now** alert.
- Again if your app asks you to calibrate more often.

Calibrating properly is important for you to get accurate sensor glucose values.

Calibration Checklist:







- ✓ Wash your hands before you check your BG
- ✓ Calibrate at least 2 times a day or when you get a **Calibrate now** alert. 3 - 4 times a day can give more accurate sensor readings.
- ✓ Enter the BG into the app right away if you want to use it to calibrate
- ✓ Don't use an old BG reading
- ✓ Don't reuse BG readings from earlier calibrations
- ✓ Wait at least 15 minutes in between calibrations



IMPORTANT: If you notice a large difference between your BG meter reading and your sensor glucose readings, wash your hands and do another BG check to make sure it is correct. Check the sensor site to ensure that the sensor tape is still holding the sensor in place. If there is still a large difference in glucose readings, you may need to do another calibration. Wait 15 minutes before you try to calibrate again.

Calibration timer:

The calibration timer tells you how much time is left until another calibration is required.

-  **12 hours left** before you need to calibrate again
-  **6 hours left** before you need to calibrate again
-  **3 hours** are left before you need to calibrate again
-  **1 hour** is left before you need to calibrate again
-  **Calibration is due now.** Calibrate using your blood glucose meter
-  **Calibration is not allowed yet**

Adjusting Alerts

Make sure to follow up with your health care professional as your settings may need to be changed.

You can change your alert settings by going to your app **Menu** and tapping **Alert Settings**:

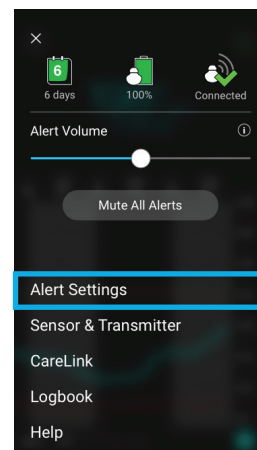

Then tap the **Low Alerts** and **High Alerts** settings you want to change.

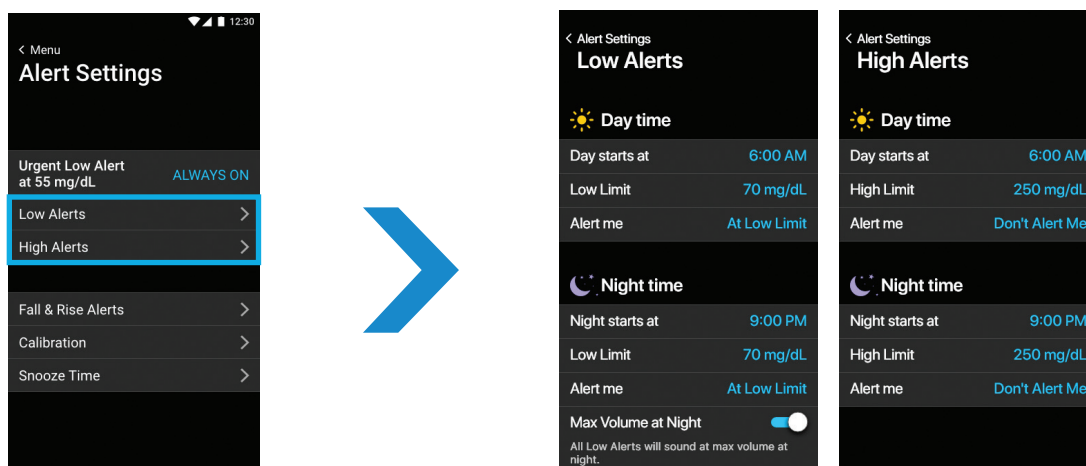

The **Urgent Low Sensor Glucose Alert** cannot be changed. It is always on. You will get an Urgent Low Sensor Glucose Alert when your sensor glucose value reaches or falls below 55 mg/dL.

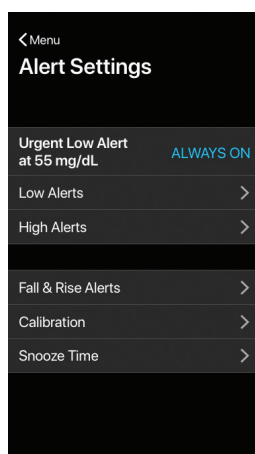

USING YOUR GUARDIAN CONNECT SYSTEM

You can tap **Fall & Rise Alerts**, **Calibration Reminder**, and **Snooze Time** to turn on and set.

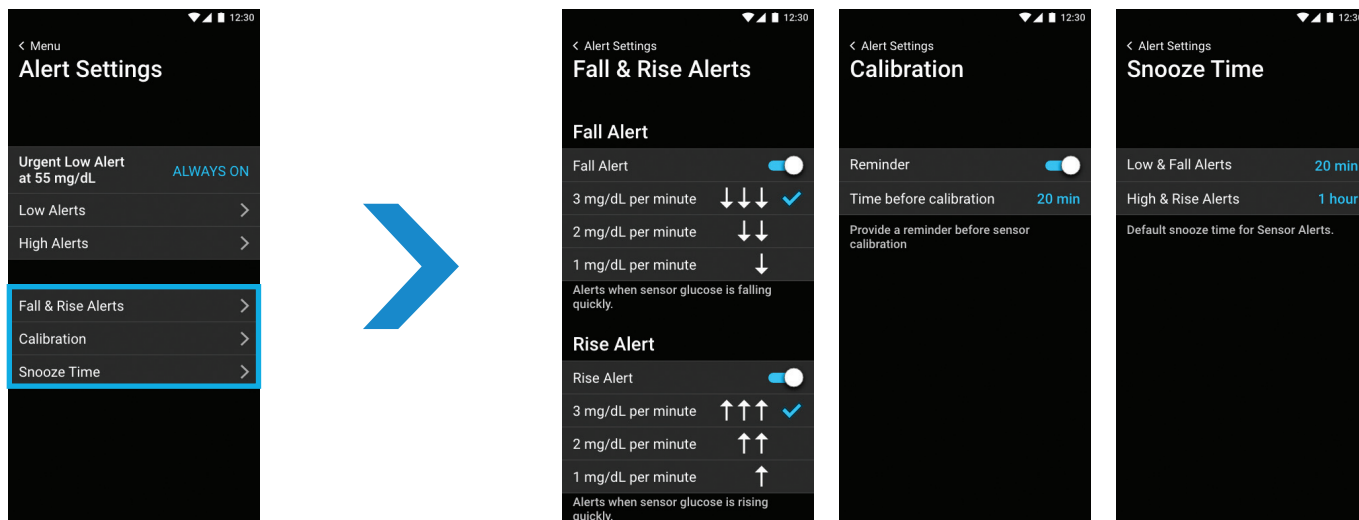

Alerts Turned Off



WARNING for Apple™ users! Do NOT turn off Notifications or Critical Alerts in your mobile device's Settings or you will not receive any Guardian Connect alerts including the Urgent Low Sensor Glucose Alert.

WARNING for Android™ users! Do NOT turn off Notifications or Do Not Disturb Permission in your mobile device's Settings or you will not receive any Guardian Connect alerts including the Urgent Low Sensor Glucose Alert.

If you see a red WARNING! on your Home screen or Menu screen, go to your mobile device's Settings and turn on Notifications and Do Not Disturb Permission if you are using an Android™ device. If you are using an Apple™ device (iPhone or iPod), turn on Critical Alerts and Notifications.

Home screen

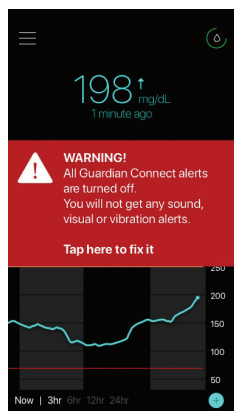

Menu screen

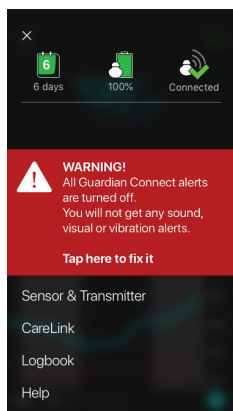

or

Apple™

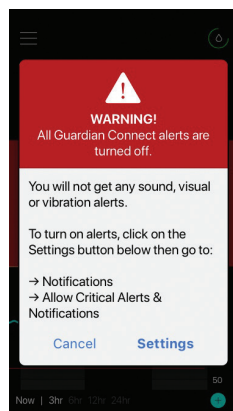

or

Android™

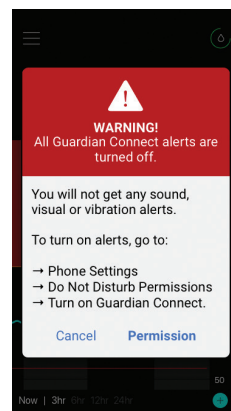
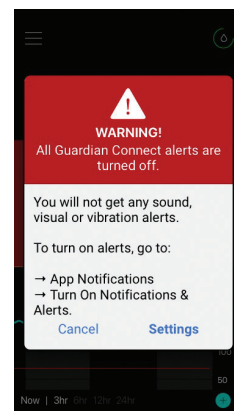

Alerts You May Receive

- High alerts will show as **orange**
- Low alerts will show as **red**
- Status alerts will show as **blue**

To **snooze the alert**, swipe the bottom of the alert screen down. Then tap the snooze time. You can change the snooze time using the **-** and **+**. The alert will be snoozed for the snooze time that you set.

Alert setting	Alert shown on screen	What it means	What you should do
At High Limit	High Sensor Glucose	Your sensor glucose value is equal to or greater than your high limit that you have set.	<ul style="list-style-type: none"> ■ Follow your healthcare professional's instructions for treating your glucose.
Before High Limit Time Before High	High Predicted	Your sensor glucose is expected to reach your high glucose limit in the length of time you have set.	
Rise Alert	Rise Alert	Your sensor glucose has been increasing at a rate that is equal to or faster than the Rise Rate that you have set: ↑, ↑↑, ↑↑↑.	
Urgent Low Alert (cannot be changed)	Urgent Low Sensor Glucose	Your sensor glucose has reached 55 mg/dL or below. You won't get an alert if your app shows that alerts are turned off. If you select Mute All Alerts in the app, then Urgent Low Sensor Glucose will vibrate only.	
At Low Limit	Low Sensor Glucose	Your sensor glucose value is equal to or lower than your low limit that you have set. This setting is in addition to Urgent Low Sensor Glucose alert.	
Before Low Limit Time Before Low	Low Predicted	Your sensor glucose is expected to reach your low glucose limit in the amount of time you have set.	
Fall Alert	Fall Alert	Your sensor glucose has been falling at a rate that is equal to or faster than the Fall Rate you have set ↓, ↓↓, ↓↓↓.	

USING YOUR GUARDIAN CONNECT SYSTEM

These sensor alerts come pre-programmed in your app with the exception of “Calibrate by” (setting is called “Calibration Reminder”). You cannot change these alerts. The app requires them.

Alert	What it means	What you should do
Calibrate now	You need to calibrate your sensor in order to get sensor glucose readings.	Wash hands and check blood glucose using a fingerstick sample and blood glucose meter. Enter blood glucose value into your Guardian™ Connect app.
Lost communication	Your Guardian™ Connect app and transmitter haven't been communicating for 30 minutes. Your app may have closed due to other apps running or because your mobile device is too far away. Other equipment may be causing radio frequency interference. Another cause is that your transmitter disconnected from your sensor or your sensor pulled out of your skin.	Open app to make sure it is running properly. Move your mobile device closer to your transmitter and sensor. Move away from equipment that can cause radio frequency interference. If it's still not working check that transmitter is still connected to sensor. If not, then reconnect it. Insert a new sensor if you see that it has pulled out. If still not working, call the 24-hour help line.
Calibration not accepted	Your BG meter value could not be used to calibrate; it was too different from the SG value.	Wait 15 minutes. Wash your hands and check your blood glucose again. Enter this blood glucose value into app.
Sensor end of life	Sensor has reached its maximum life of 7 full days.	Remove your sensor. Recharge your transmitter. Follow the instructions in this Getting Started Guide or the video in your app for inserting and starting a new sensor.
Change sensor	You may have received a second Calibration not accepted alert or the sensor is not working properly.	Remove your sensor and follow the instructions in the User Guide for inserting and starting a new sensor.
Sensor glucose not available	There is no sensor information due to several possible causes. Some causes include the sensor pulling out of your skin or your sensor not working properly.	Don't calibrate unless the app tells you to. The system is trying to correct the problem. This could take up to 3 hours. You don't need to do anything at this time.
Calibrate by	You programmed the Calibration Reminder setting to alert you when a calibration will be due.	Do a calibration by the time that the alert shows you.
Mobile device battery low	Your mobile device's battery has reached or fallen below 20% of its power.	Charge your mobile device.

 **If phone battery dies & recharges, my app will not restart automatically.**

WARNING: Don't let your mobile device shut down due to low battery, or you won't get any alerts. Carry a charger for your mobile device so that you can charge the battery.

For a complete list of Alerts, check the Guardian™ Connect System User Guide.



WARNING: If your headphones are plugged into your mobile device and you are not using them, you may not hear important alerts that require you to take action

Reading Your Sensor Display

Viewing Your Main Menu

Press  on the top left corner of your app's Home Screen. You will now see 3 icons in the system status bar. (To close the Main Menu, press X at the top left corner).

System Status

A Sensor Life Icon

After you insert a new sensor you will see how many days your sensor has left. The sensor icon will count down with each day that passes.



B Transmitter Battery Icon

When your transmitter is fully charged, the transmitter battery icon will show as solid green. The icon will change as your transmitter battery drains from 100% to 0%.

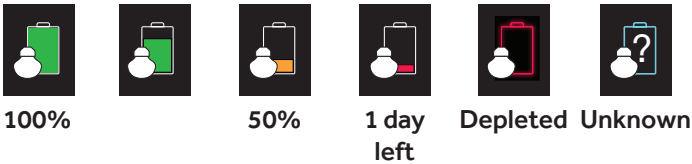

C Transmitter Communication Icon

 The transmitter is paired and communicating with your app.

 An error in communication, the transmitter is not paired, or Bluetooth® is turned off on your mobile device.



NOTE: These icons will show at the top of the main menu and home screen when your transmitter battery is low or completely drained, your transmitter is not paired, or your sensor has one day or less before it expires.



System Status

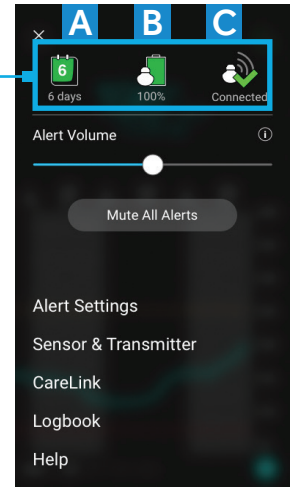

Viewing my Home Screen



Current Sensor Glucose Value

The sensor reading is updated every 5 minutes. The sensor reads glucose values from 40 mg/dL to 400 mg/dL.

You can see that the sensor glucose value in the picture above is 108 mg/dL. But also notice:

- **the sensor glucose tracing** shows the glucose has been trending downward.
- **the one arrow next to the sensor glucose value** also tells you the glucose has been dropping.

If you see:

↑ or ↓ this means your **SG has been changing** by 1-2 mg/dL per minute

↑↑ or ↓↓ this means your **SG has been changing quickly** by 2-3 mg/dL per minute

↑↑↑ or ↓↓↓ this means your **SG has been changing very quickly** by greater than 3 mg/dL per minute

Viewing my Sensor Graph

Swipe center of graph, right and left: to view past sensor information

Double tap vertical glucose line on right: to return to current glucose.

Touch SG tracing: to view more details, SG reading, time, date.

Touch event marker on graph: to view more details, event information.

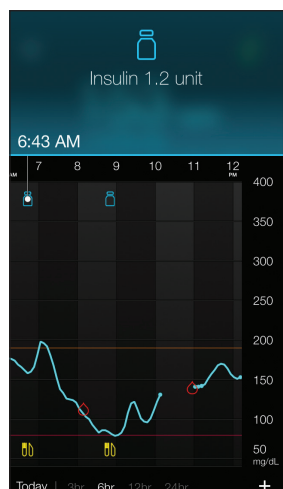

Example of an “info box” for insulin

Additional Sensor Graphs

To view 3-hour, 6-hour, 12-hour, and 24-hour glucose graphs:

- tap graph twice or
- select graph hours at bottom of Home screen.

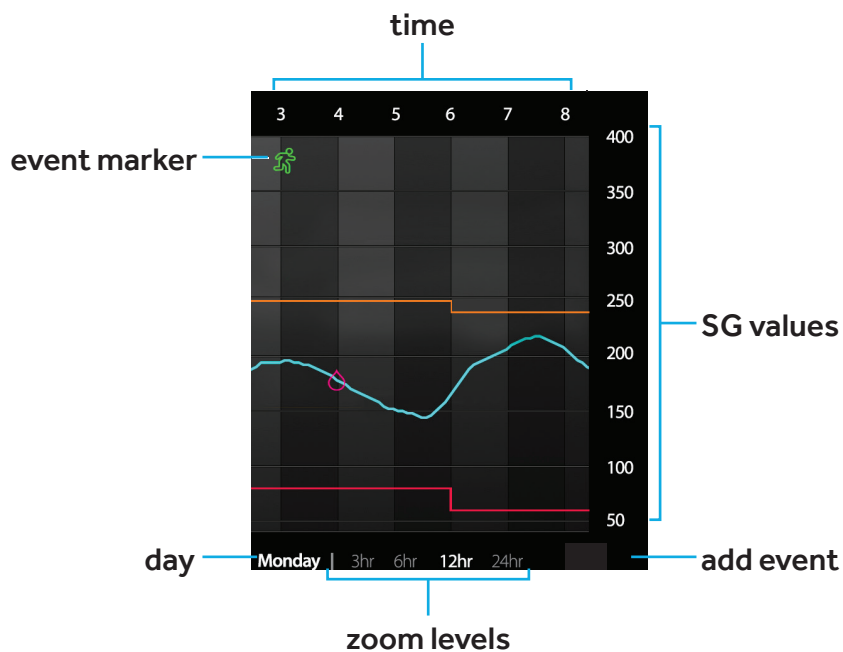

Entering Event Markers

You can capture events or other information right on your app:



Blood Glucose: Your BG meter readings. These can be used both to calibrate the sensor and to log your BG readings without calibrating the system.



Insulin: The type and amount of insulin you use.



Meal: The amount of carbohydrates you eat or drink.



Exercise: The intensity and length of exercise you do.



Notes: This event can be used to enter any other information about your diabetes management. For example, you can record when you take other medications, when you feel ill, or when you are under stress.

To enter an Event marker

1. Tap  on the bottom right corner of your home screen.
2. Tap the event icon you want
3. Enter the information for your event.
4. Tap **Save** when finished.

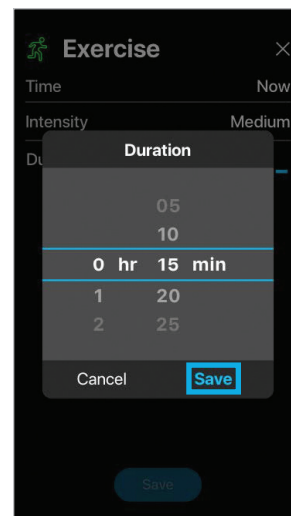
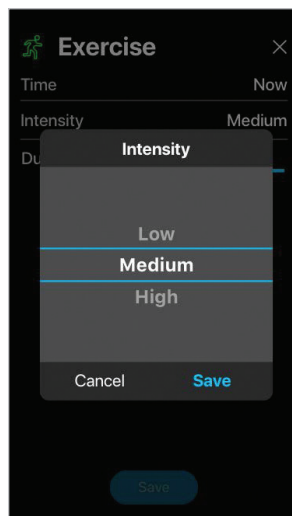
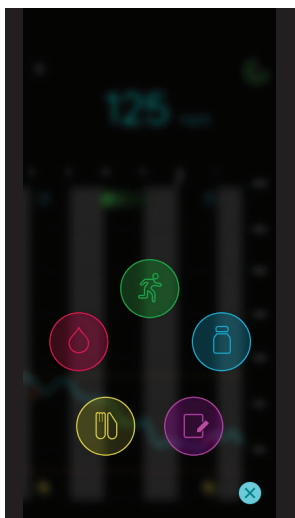

Your app returns to the home screen and the event icon shows on the graph.



NOTE: If you entered a BG reading as an event, you can also use it to calibrate the sensor.

1. Enter BG reading
2. Select **Calibrate**

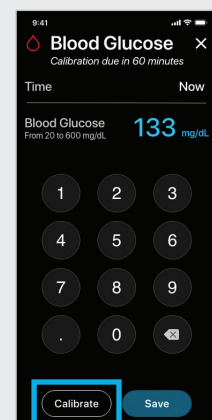

SECTION 4: SETTING UP MY CARE PARTNER ACCOUNT

Creating My Care Partner's Account and Sharing My Information

Guardian Connect lets you send your glucose data to CareLink Personal software automatically. Your sensor glucose information will show in the **CareLink Connect tab** in the CareLink Personal website every 5 minutes. You can also see your CareLink Personal reports every 24 hours. Your care partner does not need the app in order to see your sensor data.



REMINDER: Ask your healthcare professional (HCP) to look at your CareLink reports at the office or bring your reports with you to your next visit.

You can invite a family member, friend, or other care partners to view your CGM information on the CareLink Personal website by selecting **Manage Care Partners**.

1. Press  on the top left corner of the Home Screen. Tap **Sync to CareLink**.

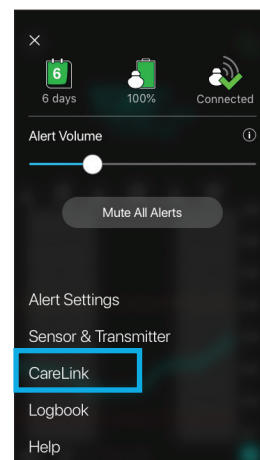

2. Be sure Sync to CareLink is turned ON. Tap **Manage Care Partners**.

Turned On

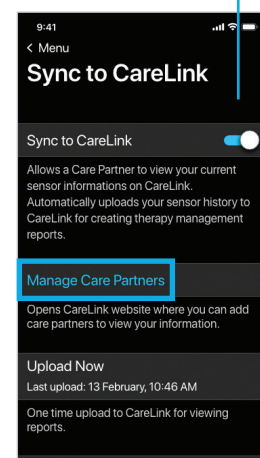

SETTING UP YOUR CARE PARTNER ACCOUNT

2a. If you are at the CareLink Connect screen, tap  on the top left corner of the screen. Tap **Connect Settings**.



3. Set a nickname for yourself. When your care partner receives a text message with an alert your nickname will appear in the message. Then tap Save.

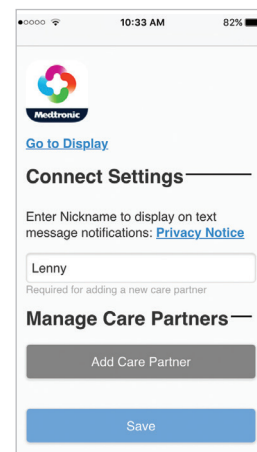

4. Tap **Add Care Partner**. Fill in the required information for your care partner (first and last name). You can add up to 5 care partners to your CareLink Personal account.

Create a unique username for your care partner and temporary password, then tap Save. This temporary password is valid for 24 hours. Give this username and password to your care partner.

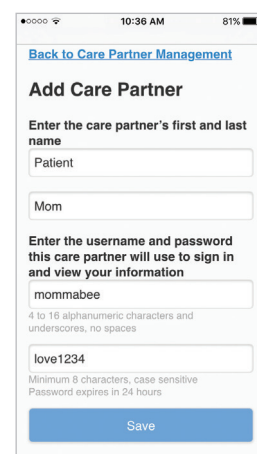

Set Up and Access to the Care Partner Account

1. Next, your care partner will need to:
 - go to the CareLink Personal website (carelink.minimed.com) using a web browser on his/her own mobile device or computer.
 - login with the username and temporary password that you created.
 - check all boxes in Terms of Use. Tap **Accept**.
 - change the temporary password to a new one. Tap **Next**.

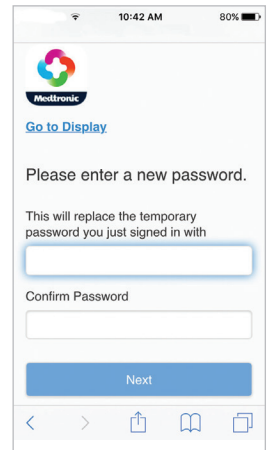

2. Your care partner will fill out the rest of the information on the My Info screen. Then tap Save.

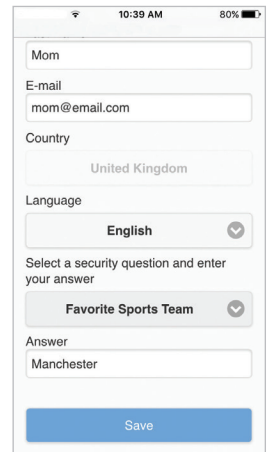
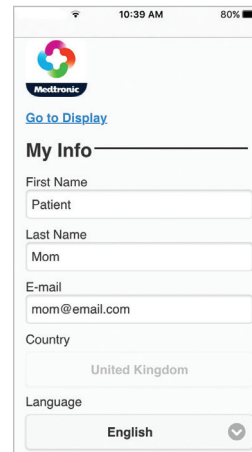

3. Your care partner must enter his/her mobile number and check the **Active** box in order to receive text message alerts. Tap Save when complete.

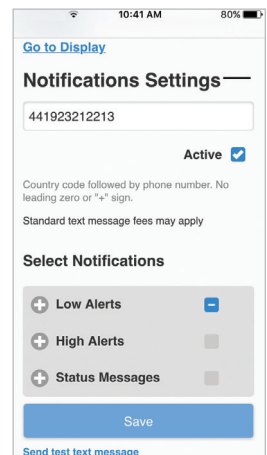

Setting Care Partner Notifications

Selecting Low Alerts and High Alerts

Your care partner can use either a computer or internet browser on a mobile device to choose what Guardian Connect alerts they want to receive. If you haven't cleared an alert in your Guardian Connect app, a text message will be sent to your care partner. The text message will be sent using the 0-30 minute delay that is set in **Select Notifications**. If your care partner does not want a delay in alerts, select 0. Once all desired notifications have been made, tap Save.

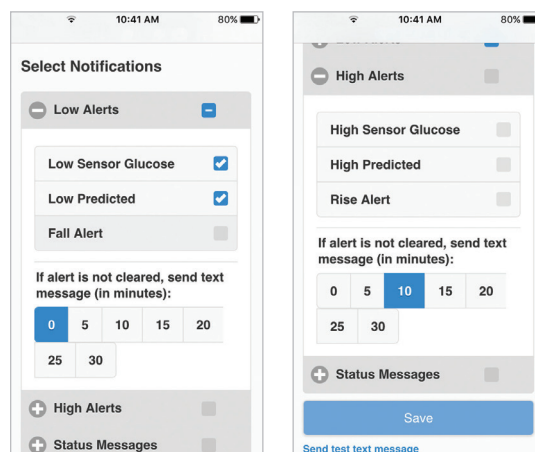

NOTE: Your care partner may only receive alerts and alarms that you have set in your Guardian Connect app regardless of the Notification(s) that your care partner chooses. For example, if you do not set High Alerts in your Guardian Connect app, your care partner will not receive High Alert messages even if it is selected in Select Notifications on the CareLink Personal website.

Selecting Status Messages

Your care partner can also choose to receive text messages for app Status Messages. If you haven't cleared the status alert on your app, a text message will be sent to your care partner using the 0-30 minute delay that is set in **Select Notifications**. If your care partner does not want a delay in alerts, select 0. Once all desired notifications have been selected, tap Save.

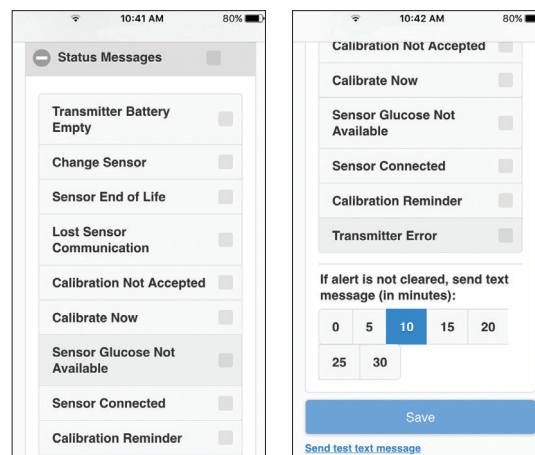

Charging and Storing My Transmitter

Charge your transmitter before each use. When your transmitter is charging, a green light will flash on the charger. This green light will turn off when your transmitter is completely charged. You will need to charge your transmitter after each sensor you use. A fully charged transmitter can be used for a maximum of seven days without recharging. It can take up to 2 hours to fully recharge.

When you remove the fully charged transmitter from the charger, you will see 10 quick green flashes on the transmitter followed by 20 minutes of slow green flashes. This means that it has enough battery power for the entire time that you're wearing it. If you do not see these two types of green flashes on your transmitter after it is removed from the charger, plug it back on to the charger until it is fully charged. Note: Once you pair the transmitter to the app, the green flashes stop. When you connect the transmitter to the sensor, the transmitter will flash for a few seconds only.

Store the transmitter, charger, and tester in a clean, dry location at room temperature. Do not store the transmitter on the charger for more than 60 days. Otherwise, the transmitter battery will be permanently damaged. If you are not using your transmitter, you must charge it at least once every 60 days.

If you connect transmitter to charger and you see no lights on the charger: replace the battery in the charger.

While charging your transmitter you see a flashing red light on the charger: replace the battery in the charger.

While charging your transmitter you see a mix of short and long flashing red lights on the charger: replace the battery in the charger and fully charge the transmitter.

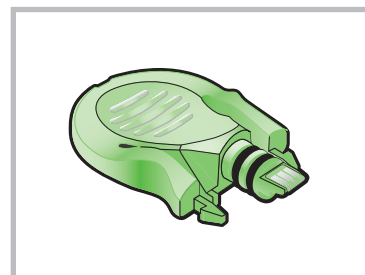
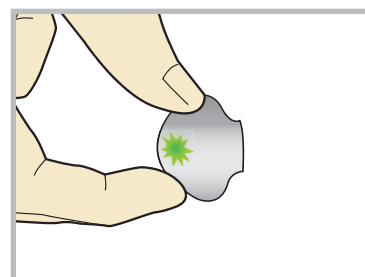
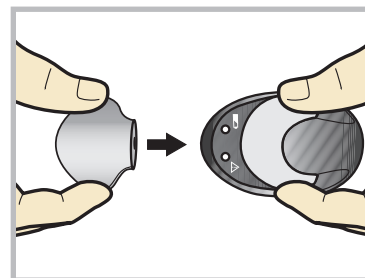

WARNING: Do not use the transmitter if you see that it's cracking, flaking, or its housing is damaged. These are signs that the transmitter is deteriorating. This deterioration can make it difficult to clean the transmitter properly and could result in serious injury.

Refer to your Guardian Connect System User Guide for more information.

Going through Airport Security

The full body scanner may be a form of x-ray. If you choose to go through the full body scanner, you will need to remove your sensor and transmitter before the scan. To avoid removing your devices, you should ask for an alternative screening process that does not use x-ray. Your CGM system can withstand exposure to metal detectors and wands used at airport security checkpoints.



Traveling by Air

If you wear a CGM device, it is safe for use on commercial airlines. If airline personnel request that you turn off your CGM device, you must comply.



NOTE: If your mobile device has returned to the locked screen, notifications from your app will also appear on this screen.

Your app must be OPEN or running in the background at all times in order for you to get sensor glucose information and alerts.

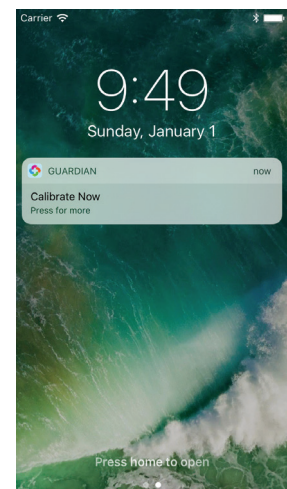



Medtronic Diabetes

18000 Devonshire Street
Northridge, CA 91325
1.800.646.4633

www.medtronicdiabetes.com

M995422A002_A

© 2020 Medtronic. All rights reserved. Medtronic,
Medtronic logo and Further, Together are trademarks of Medtronic.
All other brands are trademarks of a Medtronic company.